





# **DA-16X**

---

16-channel  
24 bit, 192 kHz, D/A Converter

**User's Guide**  
V2.0 - January 2005



## Warnings

### FCC warning

This equipment has been tested and found to comply with the limits for a Class A digital device, pursuant to Part 15 of the FCC rules. These limits are designed to provide reasonable protection against harmful interference when operated in a commercial environment. This equipment generates, uses, and can radiate radio frequency energy and, if not installed and used in accordance with the instruction manual, may cause harmful interference to radio communications. Operation of this equipment in a residential area is likely to cause harmful interference, in which case the user will be required to take whatever measures necessary to correct the interference at his own expense.

### Copyright Notice

The Apogee DA-16X is a computer-based device, and as such contains and uses software in ROMs. This software, and all related documentation, including this User’s Guide contain proprietary information which is protected by copyright laws. All rights are reserved. No part of the software and its related documentation may be copied, transferred, or modified. You may not modify, adapt, translate, lease, distribute, resell for profit or create derivative works based on the software and its related documentation or any part thereof without prior written consent from Apogee Electronics Corporation, U.S.A.

## Registration and Warranty Information

Be sure to register your DA-16X, either by filling in the enclosed Registration Card or by completing the on-line registration form at our Web site: <http://www.apogeedigital.com/support/>. If you do so, Apogee can contact you with any update information. As enhancements and upgrades are developed, you will be contacted at the registration address. Firmware updates are free for the first year of ownership unless otherwise stated. Please address any inquiries to your dealer or directly to Apogee at:

**APOGEE ELECTRONICS CORPORATION,  
3145 Donald Douglas Loop South, Santa Monica, CA 90405, USA.  
TEL: (310) 915-1000, FAX: (310) 391-6262  
email: [support@apogeedigital.com](mailto:support@apogeedigital.com). Web: <http://www.apogeedigital.com/>**

APOGEE ELECTRONICS CORPORATION warrants this product to be free of defects in material and manufacture under normal use for a period of 12 months. The term of this warranty begins on the date of sale to the purchaser. Units returned for warranty repair to Apogee or an authorized Apogee warranty repair facility will be repaired or replaced at the manufacturer's option, free of charge.

**ALL UNITS RETURNED TO APOGEE OR AN AUTHORIZED APOGEE REPAIR FACILITY MUST BE PREPAID, INSURED AND PROPERLY PACKAGED, PREFERABLY IN THEIR ORIGINAL BOX.**

Apogee reserves the right to change or improve design at any time without prior notification. Design changes are not implemented retroactively, and the incorporation of design changes into future units does not imply the availability of an upgrade to existing units.

This warranty is void if Apogee determines, in its sole business judgment, the defect to be the result of abuse, neglect, alteration or attempted repair by unauthorized personnel.

The warranties set forth above are in lieu of all other warranties, expressed or implied, and Apogee specifically disclaims any and all implied warranty of merchantability or of fitness for a particular purpose. The buyer acknowledges and agrees that in no event shall the company be held liable for any special, indirect, incidental or consequential damages, or for injury, loss or damage sustained by any person or property, that may result from this product failing to operate correctly at any time.

USA: Some states do not allow for the exclusion or limitation of implied warranties or liability for incidental or consequential damage, so the above exclusion may not apply to you. This warranty gives you specific legal rights, and you may have other rights which vary from state to state.

## Service Information

The DA-16X contains no user-serviceable components: refer to qualified service personnel for repair or upgrade. Your warranty will be voided if you tamper with the internal components. If you have any questions with regard to the above, please contact Apogee.

In the event your DA-16X needs to be upgraded or repaired, it is necessary to contact Apogee prior to shipping, and a Return Materials Authorization (RMA) number will be assigned. This number will serve as a reference for you and helps facilitate and expedite the return process. Apogee requires that shipments be pre-paid and insured — unless otherwise authorized in advance.

**IMPORTANT: ANY SHIPMENT THAT IS NOT PRE-PAID OR IS SENT WITHOUT AN RMA NUMBER WILL NOT BE ACCEPTED.**

## Declarations of Conformity

### Declaration of Conformity—FCC

#### Apogee DA-16X

This device complies with Part 15 of the FCC Rules. Operation is subject to the following two conditions:

(1) This device may not cause harmful interference

(2) This device must accept any interference received, including interference that may cause undesired operation.

This equipment has been tested and found to comply with the limits of a Class B digital device, pursuant to Part 15 of the FCC Rules. These limits are designed to provide reasonable protection against harmful interference in a residential installation. This equipment generates, uses and can radiate radio frequency energy and, if not installed and used in accordance with the instructions, may cause harmful interference to radio communications. If this equipment does cause harmful interference to radio or television reception, which can be determined by turning the equipment off and on, the user is encouraged to try to correct the interference by one or more of the following measures:

1. Re-orient or relocate the receiving antenna.
2. Increase the separation between the equipment and receiver.
3. Connect the equipment into an outlet on a different circuit from that to which the receiver is connected.
4. Consult the dealer or an experienced radio/TV technician for help.

NOTE: The use of non-shielded cable with this equipment is prohibited.

CAUTION: Changes or modifications not expressly approved by the manufacturer responsible for compliance could void the user's authority to operate the equipment.

Apogee Electronics Corporation, 3145 Donald Douglas Loop South, Santa Monica, CA 90405.  
Betty Bennett, CEO.

### Industry Canada Notice

This Class B digital apparatus meets all requirements of the Canadian Interference-Causing Equipment Regulations. Cet appareil numérique de la classe B respecte toutes les exigences du Règlement sur le matériel brouilleur du Canada.

### Declaration of Conformity – CE

Apogee Electronics Corporation hereby declares that the product, the DA-16X, to which this declaration relates, is in material conformity with the following standards or other normative documents:

- EN50081-1/EN55022; 1995
- EN50082-1/IEC 801-2, 3, 4; 1992  
following the provisions of:
- 73/23/EEC – Low Voltage Directive
- 89/336/EEC – EMC Directive

### Declaration of Conformity – Japan

Apogee Electronics Corporation hereby declares that the DA-16X, to which this declaration relates, is in material conformity with the VCCI Class A standard.

### Declaration of Conformity – Australia

Apogee Electronics Corporation hereby declares that the DA-16X is in material conformity with AN/NZS standard requirements.

## OWNER’S RECORD

The serial number is located on the rear panel of the unit. We suggest you record the serial number in the space provided below. Refer to it whenever you call an authorized Apogee Electronics repair facility or the manufacturer. Please be sure to return your completed warranty card immediately!

DA-16X Serial No. \_\_\_\_\_

Purchase Date \_\_\_\_\_

Dealer \_\_\_\_\_

Phone \_\_\_\_\_

Address \_\_\_\_\_

**CAUTION:**

**Any changes or modifications not expressly approved by APOGEE ELECTRONICS CORPORATION could void your authority to operate this equipment under the FCC rules.**

Please register this unit by filling in the included registration card, or registering online at <http://www.apogeedigital.com/support/register.php> Please read this manual – if you call for technical support, we’ll assume that you have. There will be a quiz.





# DA-16X

## User's Guide

---

### Table of Contents

<b>Introduction</b> .....	2
<b>Signal Flow Diagram</b> .....	2
<b>Getting Started Quickly</b> .....	3
Connecting Power .....	3
Reset .....	3
QuickStart .....	3
<b>Navigating the Front Panel</b> .....	4-6
Power Switch .....	4
Setup buttons .....	4
Primary Parameter Loop/Channel Cal Mode Loop .....	4
CLOCK SOURCE .....	5
SAMPLE RATE .....	5
WC Ratio .....	5
Lock indication .....	5
CAL mode indicator .....	5
OPTICAL format .....	6
AES format .....	6
INPUT .....	6
Level Meters .....	6
<b>Standard and Advanced Option Routing</b> .....	7-9
Overview .....	7
Advanced Option Routing Example: Additional Digital I/O .....	8
Advanced Option Routing Example: Expanded Interface Choices .....	9
<b>Connections on the Rear Panel</b> .....	10
OUT 1-8 .....	10
OUT 9-16 .....	10
OPTION .....	10
ADAT – S/MUX .....	10
AES IN .....	10
WC IN .....	10
WC OUT .....	10
WC IN Termination Switch .....	10
<b>Internal Adjustments</b> .....	11-12
MIDI Firmware update connector .....	11
Power switch calibration .....	12

## Introduction

The DA-16X, Apogee’s latest and most advanced digital to analog converter, takes the legendary quality of Apogee a significant step forward. Features such as a redesigned power supply, standard 192kHz sampling rates, the C777 clocking technology found in Big Ben, and optional Pro Tools HD and FireWire expansion cards, make the DA-16X the most powerful and flexible D-to-A converter ever.

### **Advanced High-Definition Conversion**

With up to 192k standard sample rates, the DA-16X combines Apogee’s legendary conversion quality with the very latest in high-definition digital to provide unrivaled flexibility and quality.

### **C777 Clocking used by Big Ben**

The DA 16-X uses Apogee’s C777 clocking technology. Famous for keeping Big Ben on time, the C777 utilizes an entirely digital process that Apogee has developed with the most advanced Direct Digital Synthesis (DDS) technology and DSP-based digital filtering. With a stable, crystal based digital PLL handling the clocking, the DA-16X is able to intelligently manipulate incoming signals and adapt to them accordingly, resulting in unprecedented jitter attenuation and an astonishing and noticeable difference in sound quality.

### **Advanced Option Routing**

With version 2 firmware, both digital inputs and analog outputs may be routed in conjunction with an installed X-Option card. Please see page 7 for details.

### **Universal Connectivity**

With it’s wide array of standard and optional digital inputs, the DA-16X can be connected to virtually any digital system. The DA-16X includes AES and ADAT Optical digital inputs as standard, while either the X-HD or X-FireWire cards may be installed for connectivity to Pro Tools HD or any FireWire equipped computer.

### **High Performance Output**

The DA-16X uses Apogee’s newly developed electronically balanced line drivers, able to simulate true transformer behavior. The circuitry is an ultra low output impedance, high current driver, capable of running levels up to 26 dBu to the most complex or low impedance loads. Recording studios utilizing vintage audio-equipment will find this particularly valuable. Ultimately, the output performance of the DA-16X achieves perfect symmetry when used in balanced mode (even with an unsymmetrical load) and no increased distortion when used unbalanced.

## Getting Started Quickly

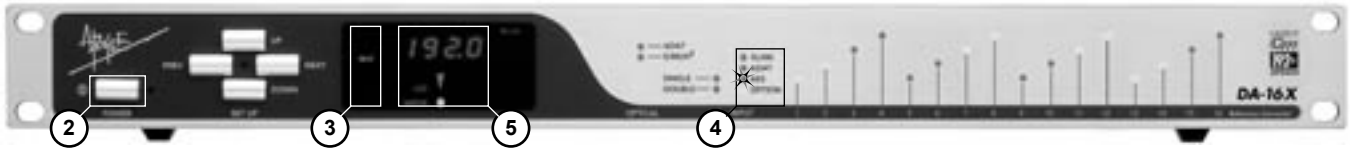

### USING THIS MANUAL

In this manual, “parameters” are defined as the characteristics of operation, such as **CLOCK SOURCE** or **AES** format, and are capitalized in this manner: **CLOCK SOURCE**.

“Values” are defined as the choices available for each parameter – for example, the parameter **CLOCK SOURCE** has the values *INTernal*, *WC* and *INPUT*. Values are italicized in this manner: *S/PDIF*.

“Settings” are defined as the entire set of parameters and values.

When physical controls such as buttons or switches are referred to in the text, they are highlighted in this manner: **DOWN**.

## INSTALLATION

Please ensure that the DA-16X is installed in a adequately ventilated location. It is recommended that a 1U space be left between units if installed in a 19” electronics rack

## CONNECTING POWER

The DA-16X accepts an AC input of 100 to 240v AC at a frequency of 50 to 60 Hz. Thus, the unit may be connected to virtually any AC power outlet found worldwide without concern for voltage settings or fuse ratings.

## RESET

To reset the DA-16X, power up the unit while pressing the **DOWN** button. This provides a quick method to return to factory default settings when exploring the unit’s functionality and capabilities. When reset, the conversion level is set so a –16 dBFS digital input results in a +4 dBu analog output.

## QUICKSTART

Follow these simple steps to get started quickly:

- 1) Connect an AC input, the desired digital inputs and analog outputs to the DA-16X’s rear panel.
- 2) Reset the DA-16X by powering up the unit while pressing the **DOWN** button.
- 3) Once the DA-16X has booted up, press the **DOWN** button repeatedly until the *INPUT* indication is lit (in the leftmost column of the Clock window).
- 4) Press the **NEXT** button repeatedly until the *AES* LED is flashing (in the column of LEDs above *INPUT*). Press the **UP** or **DOWN** buttons until the desired input is selected.
- 5) The sample rate of the input should be indicated in the Clock window, the Narrow Lock indicator should light, and audio should be present at the DA-16X’s outputs. If an X-Option card is installed, the DA-16X may be set in an Advanced Option routing configuration; please see page 8 for details.

## Navigating the Front Panel



- 1) **Power Switch** - The **POWER** switch may be configured to operate in the manner best suited to the installation of the unit; for example, if the DA-16X is installed in a rack with a Master power switch, the unit may be configured to power on when the Master switch is turned on. Please see the section of this manual entitled “Internal Adjustments” for details.

Note that the POWER switch LED indicates that the DA-16X is receiving a proper AC input, and is in Standby. The LED goes out when the DA-16X is powered on.

- 2) **Setup** buttons and LED - These buttons are used to modify all settings on the DA-16X. In general, setting modification is accomplished by :
  - a) enabling Setup mode by pressing any of the 4 buttons (the Setup LED will light and one parameter value will flash);
  - b) using the **PREV** or **NEXT** buttons to scroll to the parameter to be modified;
  - c) using the **UP** or **DOWN** buttons to select the desired parameter value.

After Setup mode is enabled, pressing the **PREV** or **NEXT** button will cycle through the DA-16X’s seven parameters - CLOCK SOURCE, SAMPLE RATE, WC ratio, OPTICAL format, AES format, INPUT and CAL mode- and then return to the first parameter. Likewise, pressing the **UP** or **DOWN** buttons will cycle through the values available for the selected parameter. Once a value is selected, it immediately becomes active, regardless if the LED is flashing to indicate that Setup mode has been enabled.

If the CAL parameter has been selected, pressing and holding either the **PREV** or **NEXT** button will allow the user to enter Channel CAL mode; it’s now possible to cycle through channels 1-16 (plus two oscillator settings) in order to make settings to individual channels. Please see page 5 for more details concerning CAL modes. Figure 1 depicts the parameter cycles of the DA-16X.

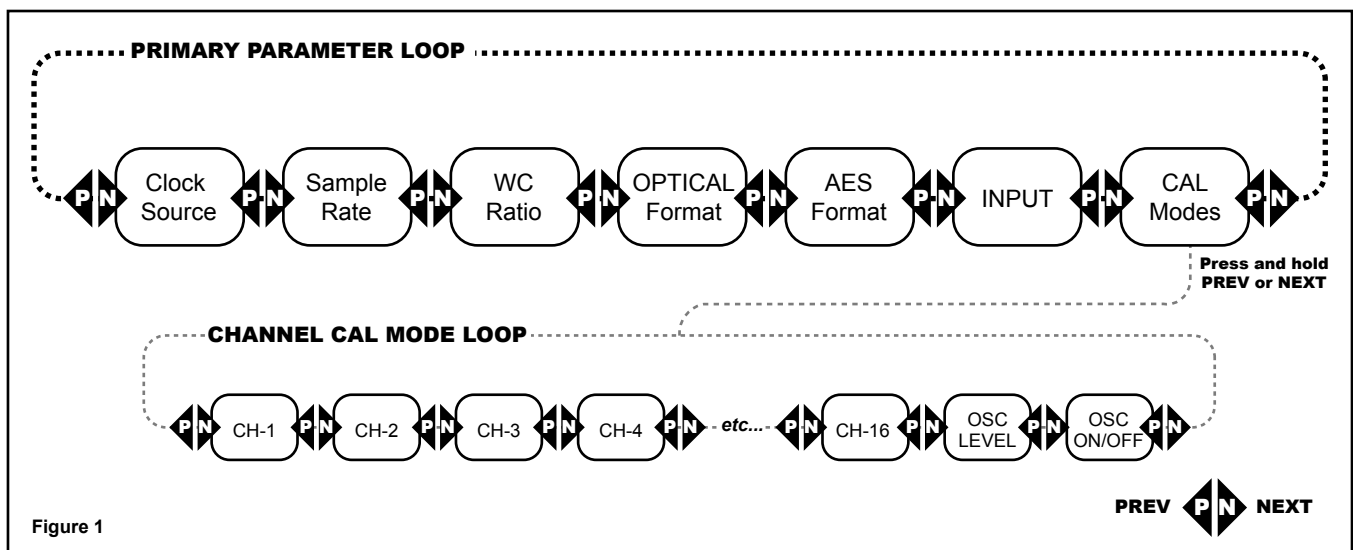

Figure 1

## Navigating the Front Panel - *continued*



Parameters 3-7 are displayed in the Clock Window, as indicated at the top of this page.

3) **CLOCK SOURCE** – This parameter determines the clock source of the DA-16X, and may be set to *IN*Ternal crystal, *WC* input, or to the digital *INPUT* (as selected by the INPUT parameter). To use Optical input as a clock or input source, the ADAT 1-8 input must be connected first in precedence. When AES input is selected as a clock or input source, all inputs are scanned until a valid input is detected; this input is utilized as the clock source.

4) **SAMPLE RATE** - When the **CLOCK SOURCE** is set to *IN*Ternal , the Sample Rate display indicates the frequency of the internally generated clock, and may be set to all standard sample rates between 44.1 and 192 kHz. When the **CLOCK SOURCE** is set to either *WC* or *INPUT*, the display indicates the sample rate of the DA-16X as a result of locking to the selected source; the sample rate cannot be set by the user.

		Word Clock I/O Frequency					
		44.1kHz	48kHz	88.2kHz	96kHz	176.4kHz	192kHz
WC Ratio Setting	WC x1:	44.1kHz	48kHz	88.2kHz	96kHz	176.4kHz	192kHz
	WC /2:	88.2kHz	96kHz	176.4kHz	192kHz		
	WC /4:	176.4kHz	192kHz				
		Resultant DA-16X Sample Rate					

Figure 2

5) **WC Ratio** – This parameter determines the ratio between the word clock Input/ Output frequency and the unit’s sample rate. Figure 2 indicates the resultant DA-16X sample rate given a specific WC Frequency Ratio setting and word clock input frequency. Likewise, the word clock output frequency may be determined given a specific WC Ratio setting and DA-16X sample rate. This parameter should be used to adjust the DA-16X word clock I/O to accommodate the requirements of specific digital systems. For example, to configure the DA-16X to lock to a 48kHz word clock input and run at a sample rate of 192kHz, set WC Ratio to *WC fs/4*.

6) **Lock indication** – These LEDs indicate the Lock status of the DA-16X’s C777 clock. Two levels of lock precision are displayed, Wide and Narrow. When the Narrow LED and Lock “exclamation point” are lit, the DA-16X has locked to the selected **CLOCK SOURCE** in such a way to ensure the highest quality D-to-A conversion. If the Wide LED or only the upper section of the Lock exclamation point lights, the stability of the clock source is questionable, and should be verified.

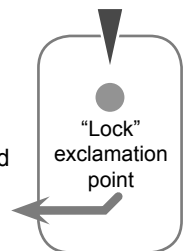

Thanks to SureLock, Apogee’s intelligent clock continuity algorithm, the DA-16X will output a stable clock signal even if the selected **CLOCK SOURCE** is interrupted. When SureLock is engaged, the arrow section of the Lock exclamation point flashes to indicate a loss of the clock source, while the Narrow LED and blue point light solidly to indicate a stable clock output.

7) **CAL mode indicator** – This LED indicates that either Global or Channel CALibration mode is enabled, and that the digital to analog conversion level may be calibrated. Global CAL allows the calibration of all 16 channels simultaneously, while Channel CAL allows calibration of individual channels. Global CAL mode is enabled by scrolling through the 7 front panel parameters until the CAL LED flashes; “global Cal” will scroll across the Sample Rate display. Once enabled, all 16 analog output levels may be adjusted by one of three operations:

- Press and Hold UP to raise the analog output level and DOWN to lower the level;
- Press and release UP or DOWN to modify the analog outputs +/-0.01 dB;
- Quickly tap UP or DOWN twice (think of a double mouse click) to modify the analog outputs +/- 1.0 dB.

This double press function may be used to quickly jump from a “house” reference level to another reference level in precise 1 dB steps.

## Navigating the Front Panel - *continued*

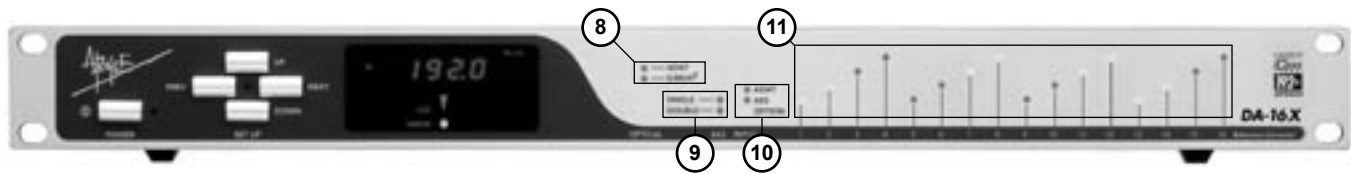

When modifying calibration levels, the Sample Rate display depicts the “wheels of gain”, which rotate clockwise to indicate increasing level and counterclockwise to indicate decreasing level, something like a volume knob.

Channel CAL mode is enabled by scrolling through the 7 front panel parameters until the CAL LED flashes, then pressing and holding either the **PREV** or **NEXT** buttons until “ch 1” scrolls across the Sample Rate display. Keeping in mind that Setup mode is **always** enabled while in Channel CAL mode, channel 1’s analog output may be modified by the same operations described on the previous page. To adjust channels 2-16, press either the **PREV** or **NEXT** button until the LED corresponding to the channel to be modified is lit.

Additionally, there are two extra parameters in the Channel CAL cycle: Oscillator On-Off and Oscillator Level. To engage the oscillator, press **PREV** or **NEXT** (while in Channel CAL mode) until “OSC – OFF” scrolls across the Sample Rate display, then press the **UP** button to turn the oscillator on (if the oscillator is on, press **DOWN** to turn it off). To set the Oscillator level, press **PREV** or **NEXT**, until “OSC – 16dBfs” scrolls across the Sample Rate display, and press **UP** or **DOWN** to set the oscillator to a value between -20 dBfs and 0 dBfs.

Saving calibration settings

To exit Channel CAL mode, press and hold either **PREV** or **NEXT** again. Keep in mind that values entered while in either Global or Channel calibration mode won’t be saved in non-volatile memory until Channel CAL mode is exited and the Setup mode LED goes out.

Individual channel level changes made in Channel Cal mode are preserved when modifying all channel levels in Global Cal mode.

To calibrate the DA-16X, engage the internal oscillator at the desired digital reference level (between -20 and -12 dBfs) and calibrate the analog outputs until the desired analog reference level (most often +4 dBu) is attained. This may be most easily accomplished by measuring the AC voltage between the plus and minus legs of each analog output, and adjusting the calibration level until a voltage of 1.23 volts AC is attained. Any modern digital voltmeter will provide a sufficiently accurate measurement.

- 8) **OPTICAL format** – The format of the Optical inputs may be set to *ADAT*, *S/MUX2* or *S/MUX4* to accommodate the Optical format of connected devices. If the **CLOCK SOURCE** is either *INTernal* or *WC*, the **OPTICAL** format is determined by the Clock Source’s sample rate, and cannot be modified. If the **CLOCK SOURCE** is *INPUT* and **INPUT** is set to *ADAT*, the **OPTICAL** format is specified by the user.
- 9) **AES format** - The format of the AES inputs may be set to *SINGLE* or *DOUBLE* wire, to accommodate the AES format of connected devices. If the **CLOCK SOURCE** is either *INTernal* or *WC* and the sample rate is 44.1- 48kHz, only the *SINGLE* value is available; in all other cases both values may be selected.
- 10) **INPUT** – The DA-16X’s digital input may be sourced from either the *ADAT*, *AES* or *OPTION* card inputs. The *OPTION* value is not accessible when no card is installed. To use Optical input as a clock or input source, the *ADAT* 1-8 input must be connected first in precedence. When the DA-16X is set to Advanced Option routing configuration, the *OPTION* LED remains lit and **INPUT** may be toggled between *ADAT* and *AES* only. Please see page 8 for details.
- 11) **Level Meters** – Much more than mere signal presence indicators, these LEDs display digital Input level from -36 to 0 dBfs according to their brightness.

## Standard and Advanced Option Routing

When an X-Option card is installed, the DA-16X may be set to one of two output configurations, Standard and Advanced Option.

When Standard routing is enabled, only one signal path is present – the selected digital input to the analog outputs. When Advanced Option routing is enabled, two signal paths are present – 1) ADAT or AES digital input to X-Option card outputs; 2) X-Option card inputs to analog outputs.

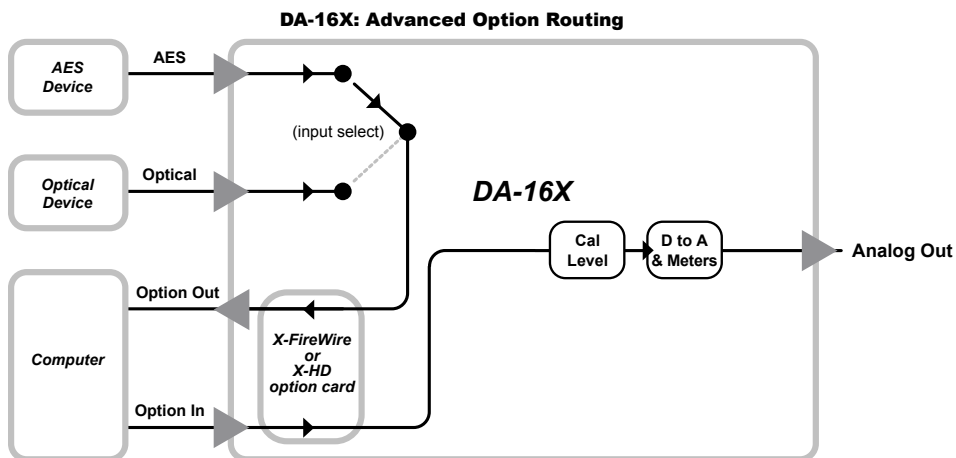
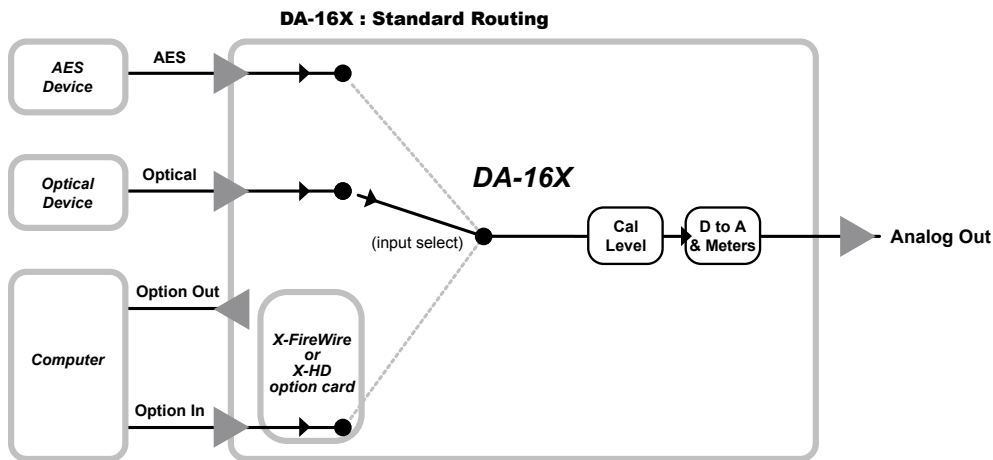

Please see pages 8 & 9 for Advanced Option Routing examples

Switching the DA-16X between Routing modes may only be accomplished when powering on the unit. To toggle between Standard and Advanced Option routing modes, press and hold the UP button while powering on the unit; when Standard routing is enabled, “Apogee DA-16X” scrolls across the Sample Rate Display; when Advanced Option routing is enabled, “Apogee DA-16X 2.0” scrolls across the Sample Rate Display

### IMPORTANT NOTES CONCERNING ADVANDED OPTION ROUTING MODE

Advanced Option routing will modify the manner in which an X-HD equipped DA-16X is detected in Pro Tools, reflecting the additional available inputs.

## Standard and Advanced Option Routing - *continued*

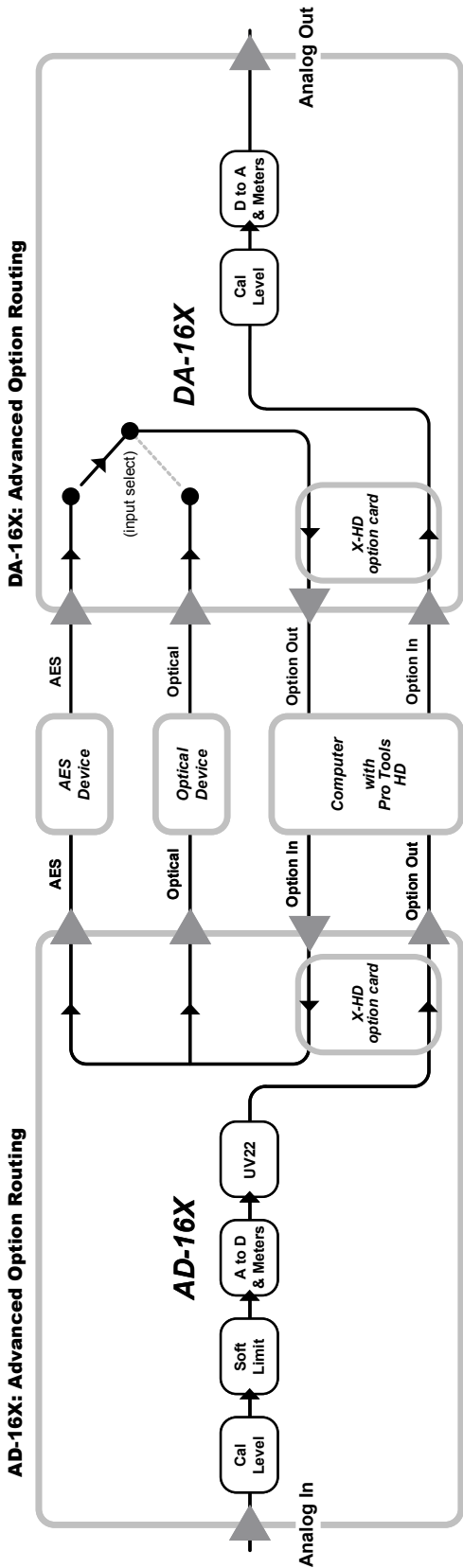

### Advanced Option Routing – Additional Digital I/O

With Advanced Option routing, the AD and DA-16X offers additional digital I/O to Digidesign HD or Firewire-based audio systems. As depicted in the routing diagram at left, when an X-HD card is installed in both an AD and DA-16X, it becomes possible to route the DA-16X’s AES or ADAT inputs *to* a Pro Tools session while routing the AD-16X’s AES and ADAT outputs *from* the session. The AD-16X functions as a Digidesign 192 with 16 analog inputs and 16 digital outputs while the DA-16X functions as a 192 with 16 digital inputs and 16 analog outputs. Of course, the same functionality is possible with X-Firewire cards and a Firewire-based audio system.



## Standard and Advanced Option Routing - *continued*

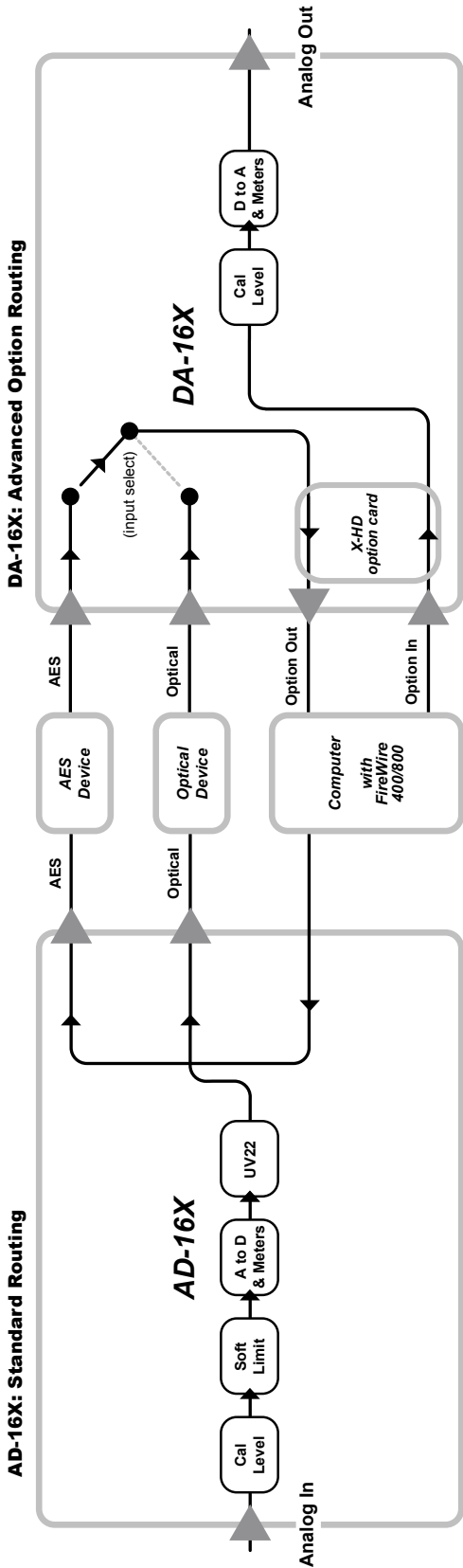

### Advanced Option Routing – Expanded Interface Choices

When an X-Option card is installed in a DA-16X, Advanced Option routing offers the possibility to connect a second interface using the DA-16X’s digital I/O. As depicted in the routing diagram at right, the DA-16X’s digital inputs are routed to the Firewire audio device while the DA-16X’s analog outputs are routed from the Firewire device. These digital inputs may be connected to an AD-16X or a MiniMe to provide analog input. In short, only one X-Option card is needed to connect a DA-16X and an A-to-D.

## Connections on the Rear Panel

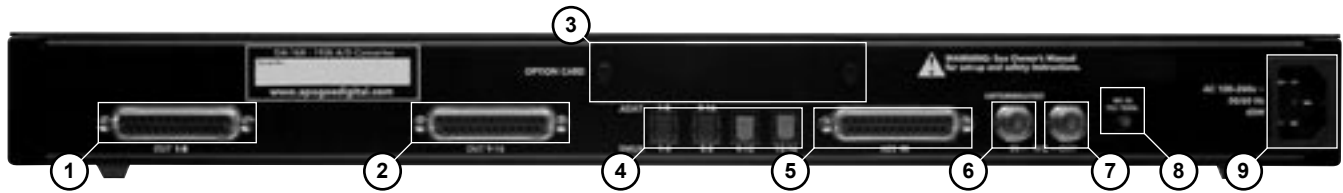

1) **OUT 1-8** - This DB-25 connection provides analog outputs 1-8; analog outputs are balanced line level signals at a nominal level adjustable between. Apogee’s DA8-IFC breakout cable can connect here to provide 8 XLR male connectors. (pinout Figure 3).

2) **OUT 9-16** - This DB-25 connection provides analog outputs 9-16. Apogee’s DA8-IFC breakout cable can connect here to provide 8 XLR male connectors (pinout Figure 3).

3) **OPTION** - This slot is reserved for Apogee’s X-Series Option cards, which provide additional digital input formats, such as FireWire or Digidesign HD.

4) **ADAT – S/MUX** These Toslink connections accept ADAT or S/MUX format optical inputs according to the front panel configuration. Figure 4 indicates the Toslink connectors used for each Optical format accepted. To use Optical input as a clock or input source, the ADAT 1-8 input must be connected first in precedence. Only 8 channels may be input when using the S/MUX 4 format.

5) **AES IN** – This DB-25 connector accepts 16 channels of AES-EBU Single wire input and 8 channels of Double wire input (pinout Figure 5). Apogee’s AES16-IP-IFC breakout cable can connect here to provide 8 XLR female connectors.

6) **WC IN** - This BNC connection accepts a TTL Logic clock signal. Termination of the word clock input may be engaged with an internal switch; please see “Internal Adjustments”.

7) **WC OUT** - This BNC connection provides a TTL Logic clock signal output.

8) **WC IN Termination Switch** - When this switch is pressed IN, a 75 ohm load is engaged across the word clock input; when the switch is OUT, the word clock input is unterminated (Figure 6).

9) **AC** - This IES connection accepts an AC input of 100 to 240 VAC at a frequency of 50 to 60 Hz.

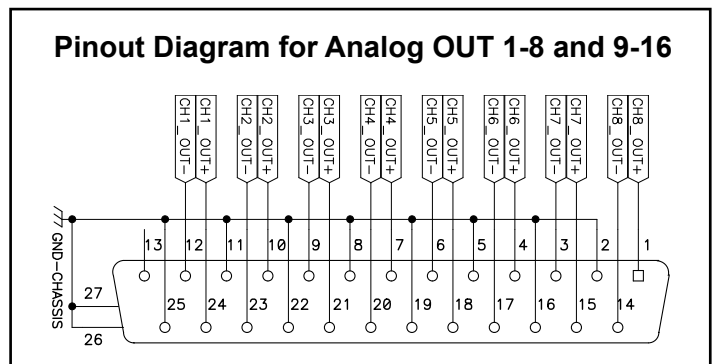

Figure 3

Rear Panel Optical Connectors				
	1	2	3	4
Optical Format	ADAT:	1-8	9-16	
	S/MUX 2:	1-4	5-8	9-12
	S/MUX 4:	1-2	3-4	5-6
				7-8

Figure 4

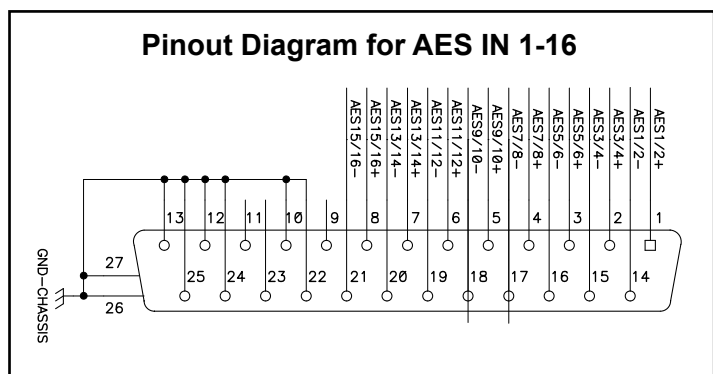

Figure 5

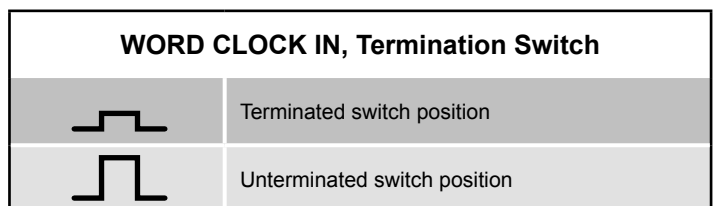

Figure 6

## Internal Adjustments



### MIDI FIRMWARE UPDATE CONNECTOR

To allow the greatest flexibility in the field, Apogee now employs a firmware update method using standard Midi protocol. You’ll need the following items to update the firmware of your Apogee device:

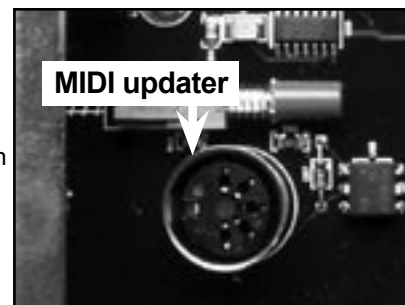

- ApogeeUpdater program, available from Apogee’s website
- New firmware file, also available from our website
- Macintosh OSX 10.2 or higher or Windows XP computer
- USB Midi interface, compatible with OS used. Please note that Midi interfaces with proprietary latency-reducing modes do not properly transmit System Exclusive data such as this firmware update. Ensure that such modes are turned off before attempting to update firmware. USB Midi Interfaces such as the Edirol PC-300, where proprietary modes may not be turned off, are not compatible with this firmware update method.

- 1) To determine the version of firmware installed in the DA 16X, press the **PREV** button while powering on the unit.
- 2) Install both the ApogeeUpdater and the new firmware file onto a computer equipped with a USB Midi Interface. It’s assumed that all drivers necessary for the proper test and operation of the Midi Interface have been installed.
- 3) Connect the DA-16X’s Midi Update Connector to an output of the Midi Interface.
- 4) On the DA-16X, simultaneously press the **PREV** and **NEXT** buttons while powering up the Apogee device; once the device has booted, release the **PREV** and **NEXT** buttons. When the signal level LEDs begin to “dance”, the unit is ready to receive data.
- 5) Open the ApogeeUpdater application, and click on **OPEN FILE**. In the Navigation window which appears, navigate to the new firmware file, select it, and click on **OPEN**.
- 6) Click on **DOWNLOAD TO UNIT**.
- 7) The complete update process takes 8 minutes; after about 1 minute, data transfer should begin and the percentage completed displayed on the ApogeeUpdater panel should correspond to the percentage displayed on the DA-16X front panel.
- 8) Once the download has reached 100%, the unit will re-boot and the front panel will return to a normal operating state.
- 9) Before proceeding, reset the unit by pressing **DOWN** while powering up the unit.



## Internal Adjustments - *continued*

### POWER SWITCH SETTINGS

<b>JUMPER P13</b> (as seen from front)	<b>DESCRIPTION</b>
	When AC power is applied to the input, the unit does not power up immediately; to power on the unit, the POWER button must be pressed.
	When AC power is applied to the input, DA-16X powers on immediately; nevertheless, the POWER switch is functional.

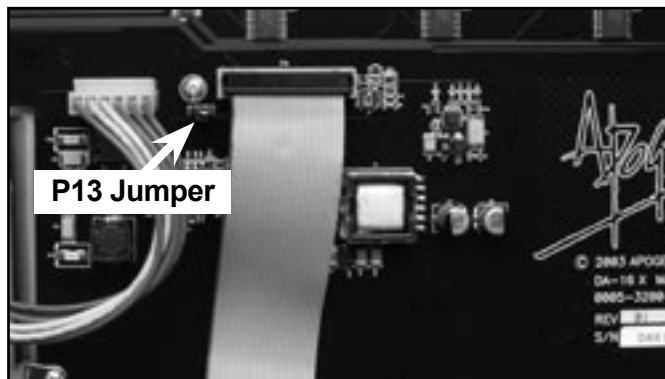



# Features and Specifications

- 16 channels of premium 24-bit D/A conversion
- Sample rates up to 192k
- 16 channels of AES, ADAT/SMUX Input
- Word Clock I/O
- Optional expansion card for direct connection to ProTools HD (X-HD card)
- Optional S800 FireWire card capable of sample rates up to 192k, compatible with OS X/Windows XP and all popular DAW's (X-FireWire card)
- All option cards (X-FireWire and X-HD) facilitate connection of multiple units
- Direct Digital Synthesis (DDS) using Big Ben's C777 Clock Technology up to 192kHz
- Master clock capability
- Adaptive Loop Filtering (ALF) for optimum clock performance and minimum jitter
- Support for AES double wire and SMUX formats
- Intuitive front panel calibration
- Word Clock termination switch

## INPUTS

- AES-EBU in x 8, transformer balanced, DSUB 25pin connector (192k single wide compatible)
- Optical: toslink x 4, supporting ADAT and SMUX protocol
- WC in: BNC 75 ohm with switchable termination

## OUTPUTS

- WC out: BNC 75 ohm
- Analog out 1-8 Balanced, DSUB 25pin connector.
- Analog out 9-16 Balanced, DSUB 25pin connector.

## OPTION SLOT

- One x-type card can be installed, for Firewire, HD and or other future format connectivity

## SPECS:

- Sample rates internal: 44.1/48/88.2/96/176.4/192k
- Sample rates external: 44.1/48/88.2/96/176.4/192k +/- 10%
- Frequency response at 44.1 k : 5 - 20.000 Hz (+/- 0.2 dB)
- Analog levels: 6 to 24dBu max through digital gain adjustment. (Compatible with -10dBV levels)
- THD+N: -107 dB
- Dynamic range: 118dB A weighted
- Power: 100 -240 VAC, 50 - 60 Hz, 65 Watt



DA-16X USER'S GUIDE - v2.0 - January 2005  
Text conceived *and* delivered by: Roger Robindore  
Graphics and product illustration by: Sean McArthur

